

**Unical**

WOOD LOGS • PELLET RANGE



## Wood and pellet-fired stoves, hydro-stoves and kitchens



- Dedicated remote control
- Integrated ioniser
- Pellet-fired stoves

- Wood-burning stoves

- Pellet-fired hydro-stoves

- Air, pellet-fired kitchens

- High water content pellet-fired boilers

- Pellet boilers
- Dual fuel: wood & pellet-fired boilers with inverted flame

- Wood-fired boilers

- Installation examples

- Bioenergy is renewability

- Regulations and certifications

## Contents

U-in / APP-O BIOEN	page 4
ION DE-vice	page 5
CUBA 5	page 6
TUA 6 2S	page 10
FATA	page 14
FATAv	page 18
NUA	page 22
TESI 10	page 26
EBA 11C	page 30
MAGA 11	page 34
TIRA 16C	page 38
LENI 10	page 42
LENI 10 ceramic	page 44
LENI 13	page 46
ONDA 17 - 24 A - 28 A	page 48
T.it K 8.8	page 52
COMPLE 2S R 20 - 24 - 34	page 56
COMPLE - COMPLE R 24	page 60
PUNTO IT CT 2S 15÷33	page 64
LAmix +34 2S	page 68
LAwood 34L 2S	page 70
FIREX 2S	page 72
SYSTEM WITH HYDRO-STOVE	page 74
SYSTEM WITH BOILER	page 76
	page 78
	page 80

## Wood and pellet-fired boilers

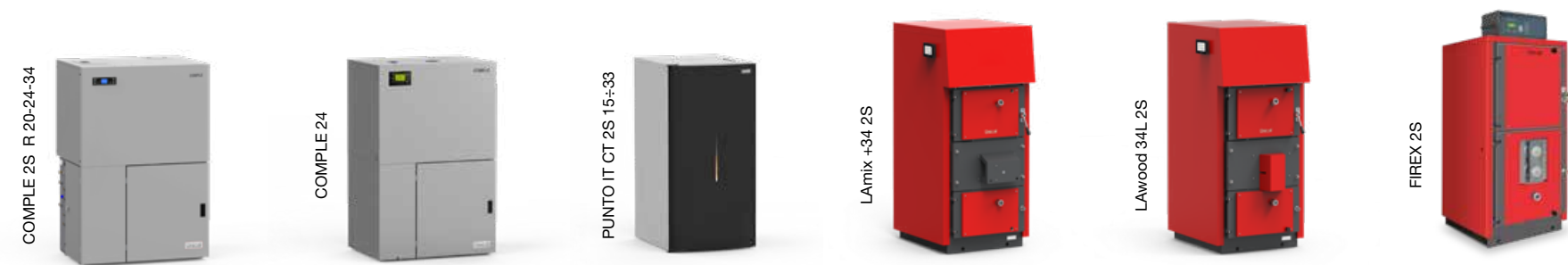

Unical, motivated by technological innovation, has always transformed its interesting intuitions into reality, for the benefit of the wider public, making the products, even if highly technological, very “user-friendly”. Unical products are safe, easy to clean and use. Conceived as furnishing elements, Unical stoves and hydro-stoves fit harmoniously into the living environment, while boilers and heat generators, for installation in the boiler room, still offer ease of maintenance, order and cleaning.

# Dedicated remote control

**U-in** is the device that, by connecting the stove with your home Wi-Fi network, allows you to manage all the services and functions of the product.



**APP-O BIOEN**, an app that allows you to manage all the main functions of the pellet stove remotely via an internet / data connection and using a smartphone or tablet.



EASY TIMER

ON / OFF



# Uin

SAVE PANEL DISPLAY

CHRONO THERMOSTAT

SILENT

TIME PROGRAMMER



# ION DE-vice

INTEGRATED IONISER by Bioxygen

The negative oxygen ions we breathe in give us a pleasant feeling of well-being, improving concentration, attention and productivity, and stimulating the immune system.

The ionisation of air in nature is determined by simple natural processes, such as solar radiation or the breaking of water. These factors act on the normally neutral air molecules, splitting them into ion pairs of opposite polarity and thus generating negative ions.

The amount of negative ions dispersed in the air varies greatly depending on the geographical location and the presence of activities that "consume" or neutralise them.

On average, 1 billion negative ions are concentrated in one cubic metre of air in the high mountains, while in the city there are around 80 million and indoors, only 5 million.



The air we breathe indoors is, strangely, much more polluted than the air outside.

Constant room ventilation is essential, but it may not be enough.

Achieving true comfort in the room means being able to regulate the right temperature and, above all, being able to breathe clean, healthy air.

This is made possible by the ioniser technology with advanced functions integrated in our pellet stoves.

## Why ionise the air

### ■ REDUCTION OF VIRUSES

A large number of microorganisms (bacteria, viruses and moulds) naturally circulate in the air and, now more than ever, it is essential to prevent their accumulation: Bioxygen technology is also tested against COVID-19.

### ■ POTENT ANTIBACTERIAL EFFECT

An essential resource for those who suffer from severe allergies or asthma, because, by purifying the air, it makes it more breathable and free of organic substances, drastically reducing breathing problems.

### ■ REMOVAL OF ODOURS AND POLLUTANTS

85% reduction of odours in the environment (sewage, chemical cleaners, smoke, etc.).

### ■ HEALTHIER AND SAFER ENVIRONMENT





# CUBA 5

VENTILATED PELLET STOVE

**Ventilated pellet stove**, particularly suitable for confined or transit spaces, thanks to its limited depth of only 29 cm. Its extremely neat front houses a ceramic glass window for viewing the flame. On the left side there is a door that can be opened to access the hearth.

**CUBA 5** can also be activated via remote control or via Wi-Fi with voice command (optional).

**CUBA 5** is set up with a retractable smoke outlet on the back or with an outlet on the top.





# CUBA 5

VENTILATED PELLETT STOVE

Unical

CUBA 5

CUBA		5
NOMINAL INPUT (min-max)	kW	2.60 - 5.52
NOMINAL OUTPUT	kW	4.95
MINIMUM OUTPUT	kW	2.35
ENERGY CLASS		<b>A+</b>
EFFICIENCY AT NOMINAL OUTPUT	%	89.63
EFFICIENCY AT MINIMUM OUTPUT	%	90.24
AVERAGE CONSUMPTION (at min.-nom.)	kg/h	0.55 - 1.16
HEATING VOLUME datum referred to well insulated houses. 18/20 °C - coefficient 0.045 kW/m³ (min-max)	m³	52 - 110
PELLET RESERVOIR CONTENT	kg	11
SMOKE OUTLET Ø	mm	80
DIMENSIONS (L x D x H)	mm	490 x 290 x 880
WEIGHT	kg	45



Black

White

Burgundy

## PRODUCT PLUS VALUES



VENTILATED STOVE



CERAMIC GLASS



CAST IRON BRAZIER



POWER MODULATION



REAR SMOKE OUTLET



UPPER SMOKE OUTLET



DAILY PROGRAMMING

## OPTIONAL



REMOTE CONTROL



WI-FI



COMPATIBLE WITH amazon alexa



# TUA 6 2S

VENTILATED PELLET STOVE

**Ventilated pellet stove**, a synthesis of tradition and innovation. The protective front panel transforms it into a piece of heating furniture; it is in fact available in nine variants and colours that allow you to choose the style by emphasizing the personality of the environment where the stove is placed.

An App also allows you to manage the stove remotely, from your smartphone or tablet, in full convenience (Wi-Fi optional kit).



# TUA 6 2S

VENTILATED PELLETT STOVE

Unical

TUA 6 2S

TUA 2S		6
NOMINAL INPUT (min-max)	kW	3.45 - 7
NOMINAL OUTPUT	kW	6.2
MINIMUM OUTPUT	kW	3.1
ENERGY CLASS		<b>A+</b>
EFFICIENCY AT NOMINAL OUTPUT	%	88.5
EFFICIENCY AT MINIMUM OUTPUT	%	89.8
AVERAGE CONSUMPTION (at min.-nom.)	kg/h	0.72 - 1.47
HEATING VOLUME datum referred to well insulated houses. 18/20 °C - coefficient 0.045 kW/m³ (min-max)	m³	68 - 138
PELLET RESERVOIR CONTENT	kg	11
SMOKE OUTLET Ø	mm	80
DIMENSIONS (L x D x H)	mm	426 x 518 x 827
WEIGHT	kg	45



3D skull classic heart

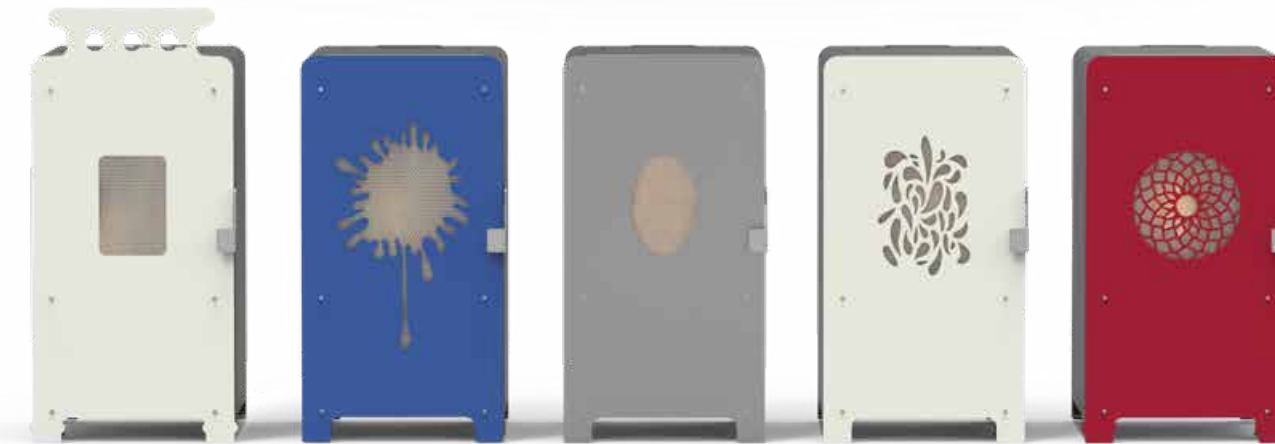

grandmother splash ellipse drops mandala

## PRODUCT PLUS VALUES



VENTILATED STOVE



CERAMIC GLASS



CAST IRON BRAZIER



POWER MODULATION



REAR SMOKE OUTLET



DAILY PROGRAMMING

## OPTIONAL



REMOTE CONTROL



WI-FI



COMPATIBLE WITH amazon alexa







# FATA

VENTILATED PELLE T STOVE

**Ventilated pellet stove** with steel structure and clean and modern aesthetics. FATA guarantees an immediate response thanks to the innovative quartz pellet ignitor, with high efficiency and low consumption.

**FATA** is controlled via the intelligent handheld "PAm" with built-in ambient probe, for homogeneous heat and comfort distribution in the room. It can also be managed from a smartphone, thanks to the advanced technology of the "U-in Plus" connection device, supplied as standard, and to the dedicated free app "APP-O BIOEN".

Healthy and safe heat thanks to the exclusive ionizer (optional) which can sanitize the air in the room up to 99% from suspended microparticles, mites, pollen, bacteria, etc.

**FATA**, 12C version (ducted), equipped with independent and adjustable ventilation, allows the diffusion of heat in several domestic environments.



# FATA

VENTILATED PELLE T STOVE

Unical

FATA

FATA		7	9	11	12C
NOMINAL INPUT (min-max)	kW	3.2 - 7.2	3.2 - 9.0	3.2 - 11.1	3.2 - 12.1
NOMINAL OUTPUT	kW	6.6	8.1	9.9	10.7
MINIMUM OUTPUT	kW	3.1	3.1	3.1	3.1
ENERGY CLASS		A++	A+	A+	A+
EFFICIENCY AT NOMINAL OUTPUT	%	92.2	90.7	88.9	88.2
EFFICIENCY AT MINIMUM OUTPUT	%	94.5	94.5	94.5	94.5
AVERAGE CONSUMPTION (at min.-nom.)	kg/h	0.67 - 1.49	0.67 - 1.85	0.67 - 2.30	0.67 - 2.51
HEATING VOLUME datum referred to well insulated houses. 18/20 °C - coefficient 0.045 kW/m³ (max)	m³	140	180	218	237
PELLET RESERVOIR CONTENT	l/kg	29.5 / 19	29.5 / 19	29.5 / 19	29.5 / 19
SMOKE OUTLET Ø	mm	80	80	80	80
DIMENSIONS (L x D x H)	mm	490 x 560 x 1100	490 x 560 x 1100	490 x 560 x 1100	490 x 560 x 1100
WEIGHT	kg	100	100	100	102

## PRODUCT PLUS VALUES

- VENTILATED STOVE
- STEEL BRAZIER
- RADIO CONTROL WITH ROOM PROBE
- "SILENT" FUNCTION
- DUCTED (mod. 12C)
- POWER MODULATION
- REMOVABLE HANDLE
- QUARTZ IGNITER
- CERAMIC GLASS
- REAR SMOKE OUTLET
- DAILY / WEEKLY PROGRAMMING
- WI-FI U-in Plus

## OPTIONAL

- AIR IONISER
- ROOM TEMP. PROBE



Black

White

Burgundy



PALMTOP "PAm"  
(std supply)



ION DE-vice  
(optional)



APP-O BIOEN





# FATAv

VENTILATED PELLET STOVE

**Ventilated pellet stove** of great elegance, thanks to the front and side cladding entirely in "Night View" glass, which becomes transparent when switched on, highlighting the flame in the hearth.

FATAv guarantees an immediate response thanks to the innovative quartz pellet igniter with high efficiency and low consumption.

FATAv is controlled via the intelligent handheld "PAm" with built-in ambient probe, for homogeneous heat and comfort distribution in the room. It can also be managed from a smartphone, thanks to the advanced technology of the "U-in Plus" connection device supplied as standard, and to the dedicated free app "APP-O BIOEN".

Healthy and safe heat thanks to the exclusive ionizer (optional) which can sanitize the air in the room up to 99% from suspended microparticles, mites, pollen, bacteria, etc.

FATAv, 12C version (ducted), equipped with independent and adjustable ventilation, allows the diffusion of heat in several domestic environments.





# FATAv

VENTILATED PELLET STOVE

Unical

FATAv

FATAv		7	9	11	12C
NOMINAL INPUT (min-max)	kW	3.2 - 7.2	3.2 - 9.0	3.2 - 11.1	3.2 - 12.1
NOMINAL OUTPUT	kW	6.6	8.1	9.9	10.7
MINIMUM OUTPUT	kW	3.1	3.1	3.1	3.1
ENERGY CLASS		A++	A+	A+	A+
EFFICIENCY AT NOMINAL OUTPUT	%	92.2	90.7	88.9	88.2
EFFICIENCY AT MINIMUM OUTPUT	%	94.5	94.5	94.5	94.5
AVERAGE CONSUMPTION (at min.-nom.)	kg/h	0.67 - 1.49	0.67 - 1.85	0.67 - 2.30	0.67 - 2.51
HEATING VOLUME datum referred to well insulated houses. 18/20 °C - coefficient 0.045 kW/m³ (max)	m³	140	180	218	237
PELLET RESERVOIR CONTENT	l/kg	29.5 / 19	29.5 / 19	29.5 / 19	29.5 / 19
SMOKE OUTLET Ø	mm	80	80	80	80
DIMENSIONS (L x D x H)	mm	490 x 560 x 1100	490 x 560 x 1100	490 x 560 x 1100	490 x 560 x 1100
WEIGHT	kg	100	100	100	102



PALMTOP "PAm"  
(std supply)



ION DE-vice  
(optional)



APP-O BIOEN



## PRODUCT PLUS VALUES

- VENTILATED STOVE
- STEEL BRAZIER
- RADIO CONTROL WITH ROOM PROBE
- "SILENT" FUNCTION
- DUCTED (mod. 12C)
- POWER MODULATION
- REMOVABLE HANDLE
- QUARTZ IGNITER
- NIGHT VIEW GLASS
- REAR SMOKE OUTLET
- DAILY / WEEKLY PROGRAMMING
- WI-FI U-in Plus

## OPTIONAL

- AIR IONISER
- ROOM TEMP. PROBE



# NUA

VENTILATED PELLE T STOVE

**Ventilated pellet stove** with steel structure, NUA is the new expression of modern aesthetics. Its innovative design is configured as a real piece of furniture that enhances and completes the spaces of the house, distributing its enveloping warmth.

Structure and top in painted steel, Champagne or Silver. Firebox designed without visible technical elements. Elegant when switched off, radiant during operation, thanks to the "Night View" ceramic glass door with retractable handle.

The upper steel top, without controls, hides a large pellet tank, which can be accessed with a simple gesture to top up the fuel.

The control of NUA is guaranteed by the presence of the exclusive mobile palmtop "PAm" with simple touch controls.



# NUA

VENTILATED PELLET STOVE

Unical

NUA

NUA		7	9	11C
NOMINAL INPUT (min-max)	kW	3.2 - 9.0	3.2 - 11.1	3.2 - 12.1
NOMINAL OUTPUT	kW	8.1	9.9	10.7
MINIMUM OUTPUT	kW	3.1	3.1	3.1
ENERGY CLASS		A+	A+	A+
EFFICIENCY AT NOMINAL OUTPUT	%	90.7	88.9	88.2
EFFICIENCY AT MINIMUM OUTPUT	%	94.5	94.5	94.5
AVERAGE CONSUMPTION (at min.-nom.)	kg/h	0.67 - 1.85	0.67 - 2.30	0.67 - 2.51
HEATING VOLUME datum referred to well insulated houses. 18/20 °C - coefficient 0.045 kW/m³ (max)	m³	280	290	290
PELLET RESERVOIR CONTENT	kg	17	17	17
SMOKE OUTLET Ø	mm	80	80	80
DIMENSIONS (L x D x H)	mm	540 x 560 x 1060	540 x 560 x 1060	540 x 560 x 1060
WEIGHT	kg	90	90	90



## PRODUCT PLUS VALUES



VENTILATED STOVE



DUCTED (mod. 11C)



NIGHT VIEW GLASS



STEEL BRAZIER



POWER MODULATION



REAR SMOKE OUTLET



RADIO CONTROL WITH ROOM PROBE



REMOVABLE HANDLE



DAILY / WEEKLY PROGRAMMING



"SILENT" FUNCTION



QUARTZ IGNITER



WI-FI U-in Plus

## OPTIONAL



AIR IONISER



ROOM TEMP. PROBE



PALMTOP "PAm" (std supply)



ION DE-vice (optional)



Champagne

Silver



APP-O BIOEN







# TESI 10

VENTILATED PELLETT STOVE

Ventilated pellet stove with a classic design with front and upper grilles for the diffusion of warm air into the room. **TESI 10** is entirely made of painted steel, with cast iron brazier.

Simple management via the control panel or directly with your smartphone through the optional App.

**TESI 10** allows the smoke outlet to disappear on the back or on the top.



# TESI 10

VENTILATED PELLETT STOVE

Unical

TESI 10

TESI		10
NOMINAL INPUT (min-max)	kW	3.3 - 9.7
NOMINAL OUTPUT	kW	8.70
MINIMUM OUTPUT	kW	3.0
ENERGY CLASS		<b>A+</b>
EFFICIENCY AT NOMINAL OUTPUT	%	89.5
EFFICIENCY AT MINIMUM OUTPUT	%	91.3
AVERAGE CONSUMPTION (at min.-nom.)	kg/h	0.68 - 2.02
HEATING VOLUME datum referred to well insulated houses. 18/20 °C - coefficient 0.045 kW/m³ (min-max)	m³	67 - 193
PELLET RESERVOIR CONTENT	kg	13
SMOKE OUTLET Ø	mm	80
DIMENSIONS (L x D x H)	mm	440 x 480 x 1000
WEIGHT	kg	52



Black

White

Burgundy

## PRODUCT PLUS VALUES



VENTILATED STOVE



CERAMIC GLASS



CAST IRON BRAZIER

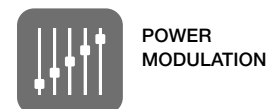

POWER MODULATION



REAR SMOKE OUTLET



UPPER SMOKE OUTLET



DAILY PROGRAMMING

## OPTIONAL



REMOTE CONTROL



WI-FI



COMPATIBLE WITH amazon alexa





# EBA 11C

VENTILATED PELLET STOVE

**Ventilated space-saving ducted pellet stove** with steel structure. The ideal solution for narrow rooms to be heated where the only 36 cm depth of EBA 11C makes the difference.

The diffusion of heat with standard ducting allows you to heat adjacent rooms.

Exclusive standard electronics with "PAm" intelligent palmtop and Wi-Fi U-in plus. With the free app "APP-O BIOEN" the management of EBA 11C is also possible via your Smartphone





# EBA 11C

VENTILATED PELLET STOVE

Unical

EBA 11C

EBA		11C
NOMINAL INPUT (min-max)	kW	10.8
NOMINAL OUTPUT	kW	10.0
MINIMUM OUTPUT	kW	4.22
ENERGY CLASS		
EFFICIENCY AT NOMINAL OUTPUT	%	93.0
EFFICIENCY AT MINIMUM OUTPUT	%	96.9
AVERAGE CONSUMPTION (at min.-nom.)	kg/h	0.908 / 2.248
HEATING VOLUME datum referred to well insulated houses. 18/20 °C - coefficient 0.045 kW/m³ (max)	m³	220
PELLET RESERVOIR CONTENT	l/kg	15
SMOKE OUTLET Ø	mm	80
DIMENSIONS (L x D x H)	mm	795 x 363 x 1041
WEIGHT	kg	111



Black



White



Burgundy

## PRODUCT PLUS VALUES



VENTILATED STOVE



DUCTED



CERAMIC GLASS



STEEL BRAZIER



POWER MODULATION



REAR SMOKE OUTLET



UPPER SMOKE OUTLET



RADIO CONTROL WITH ROOM PROBE



DAILY / WEEKLY PROGRAMMING



QUARTZ IGNITER



WI-FI U-in Plus

## OPTIONAL



ROOM TEMP. PROBE



PALMTOP "PAm"  
(std supply)



APP-O BIOEN



# MAGA 11

VENTILATED PELLET STOVE

**Ventilated pellet stove** with elegant, bevelled front cover, in painted steel and retractable handle.

**MAGA 11** is equipped with a double door with retractable handle, made of ceramic glass and Magic Black glass, so that, when the stove is on, the flame will appear in the hearth spreading heat and light into the environment, whilst, when it is switched off, the elegant glass Magic Black will return to the protagonist, by concealing the interior.

Reduced cleaning and emptying interventions thanks to the rotating brazier which, also, guarantees constant combustion efficiency with removal of deposits.





# MAGA 11

VENTILATED PELLETT STOVE

Unical

MAGA 11

MAGA		11
NOMINAL INPUT (min-max)	kW	4.8 - 11.7
NOMINAL OUTPUT	kW	10.3
MINIMUM OUTPUT	kW	4.5
ENERGY CLASS		<b>A+</b>
EFFICIENCY AT NOMINAL OUTPUT	%	88.1
EFFICIENCY AT MINIMUM OUTPUT	%	93.1
AVERAGE CONSUMPTION (at min.-nom.)	kg/h	1.0 - 2.41
HEATING VOLUME datum referred to well insulated houses. 18/20 °C - coefficient 0.045 kW/m³ (min-max)	m³	100 - 229
PELLET RESERVOIR CONTENT	kg	19
SMOKE OUTLET Ø	mm	80
DIMENSIONS (L x D x H)	mm	538 x 513 x 1020
WEIGHT	kg	95



Black

White

Burgundy

## PRODUCT PLUS VALUES

- VENTILATED STOVE
- MAGIC GLASS
- CERAMIC GLASS
- AUTOMATIC BRAZIER CLEANING
- POWER MODULATION
- REAR SMOKE OUTLET
- SIDE SMOKE OUTLET
- DAILY / WEEKLY PROGRAMMING
- DOSING VALVE

## OPTIONAL

- DUCTABLE
- WI-FI



# TIRA 16C

VENTILATED PELLET STOVE

**Ducted pellet stove** with a soft and rounded design. The top is entirely in soapstone, the door is in painted steel, while the side panels are made entirely of an elegant rounded black glass.

The high power of **TIRA** makes it ideal for use in large spaces such as lounges, attics, verandas. **TIRA** diffuses warm air through three outlets: two on the front side and one, ductable, on the rear.

Cleaning and ashes emptying operations are reduced thanks to the presence of the rotary brazier which guarantees constant combustion efficiency with removal of deposits, even during operation.





# TIRA 16C

VENTILATED PELLET STOVE

Unical

TIRA 16C

TIRA		16C
NOMINAL INPUT (min-max)	kW	6.5 - 16.4
NOMINAL OUTPUT	kW	14.6
MINIMUM OUTPUT	kW	6.0
ENERGY CLASS		
EFFICIENCY AT NOMINAL OUTPUT	%	89.3
EFFICIENCY AT MINIMUM OUTPUT	%	93.0
AVERAGE CONSUMPTION (at min.-nom.)	kg/h	1.3 - 3.3
HEATING VOLUME datum referred to well insulated houses. 18/20 °C - coefficient 0.045 kW/m³ (min-max)	m³	133 - 324
PELLET RESERVOIR CONTENT	kg	19
SMOKE OUTLET Ø	mm	80
DIMENSIONS (L x D x H)	mm	718 x 529 x 1155
WEIGHT	kg	165



## PRODUCT PLUS VALUES



VENTILATED STOVE



DUCTED



CERAMIC GLASS



AUTOMATIC BRAZIER CLEANING



POWER MODULATION



UPPER SMOKE OUTLET



DAILY / WEEKLY PROGRAMMING



DOSING VALVE

## OPTIONAL



WI-FI





# LENI 10

WOOD-BURNING STOVE

**Unical**



**ECO  
DESIGN  
2022**



LENI		10
NOMINAL INPUT	kW	10
NOMINAL OUTPUT	kW	6.9
ENERGY CLASS		<b>A+</b>
EFFICIENCY AT NOMINAL OUTPUT	%	86.9
AVERAGE CONSUMPTION	kg/h	1.83
HEATING VOLUME datum referred to well insulated houses. 18/20 °C - coefficient 0.045 kW/m³ (max)	m³	180
SMOKE OUTLET Ø	mm	150
DIMENSIONS (L x D x H)	mm	475 x 650 x 1040
WEIGHT	kg	130

**Compact wood-burning stove** with a large combustion chamber to accommodate loads for long autonomy.

**LENI 10** heats the room by radiation.

Door with steel frame, hinged opening and ceramic glass with a wide view of the flame. Steel finish.

## PRODUCT PLUS VALUES



CERAMIC  
GLASS



UPPER SMOKE  
OUTLET







# LENI 10 ceramic

VENTILATED WOOD STOVE

**Unical**



## LENI

## 10 ceramic

NOMINAL INPUT (min-max)	kW	10
NOMINAL OUTPUT	kW	6.9
ENERGY CLASS		<b>A+</b>
EFFICIENCY AT NOMINAL OUTPUT	%	86.9
AVERAGE CONSUMPTION	kg/h	1.83
HEATING VOLUME datum referred to well insulated houses. 18/20 °C - coefficient 0.045 kW/m³ (max)	m³	190
SMOKE OUTLET Ø	mm	150
DIMENSIONS (L x D x H)	mm	475 x 650 x 1040
WEIGHT	kg	130

**Ventilated compact wood stove** with a large combustion chamber to accommodate loads that ensure long burn times.

**LENI 10 ceramic** heats the room by radiation and ventilated air.

Door with steel frame, hinged opening and ceramic glass with a wide view of the flame. Ceramic finish. Hot air regulation by remote control with forced ventilation.

### PRODUCT PLUS VALUES



VENTILATED STOVE



CERAMIC GLASS



UPPER SMOKE OUTLET



"SILENT" FUNCTION



REMOTE CONTROL







# LENI 13

VENTILATED WOOD STOVE

**Unical**



**ECO DESIGN**  
2022



## LENI

**13**

GLOBAL HEAT OUTPUT	kW	12.8
NOMINAL OUTPUT	kW	11.1
MINIMUM OUTPUT	kW	4.7
ENERGY CLASS		<b>A+</b>
EFFICIENCY AT NOMINAL OUTPUT	%	86.8
AVERAGE CONSUMPTION	kg/h	2.98
HEATING VOLUME datum referred to well insulated houses. 18/20 °C - coefficient 0.045 kW/m³ (max)	m³	290
SMOKE OUTLET Ø	mm	130
DIMENSIONS (L x D x H)	mm	550 x 435 x 1025
WEIGHT	kg	110

**Ventilated compact wood stove** with a large combustion chamber to accommodate loads that ensure long burn times.

**LENI 13** heats the room by radiation and with ventilated air adjustable at double speed on the upper top. Door with steel frame, hinged opening and ceramic glass with a wide view of the flame. Hot air regulation with forced ventilation.

Large ash drawer. Practical and elegant burn-protection handle.

## PRODUCT PLUS VALUES



VENTILATED STOVE



CERAMIC GLASS



UPPER SMOKE OUTLET



"SILENT" FUNCTION







# ONDA

VENTILATED PELLE T HYDRO-STOVE

The **ONDA pellet hydro-stove**, equipped with a double front door with an elegant all-over "Magic Black" glass cover, is suitable for connection to the home heating system.

**ONDA**, in addition to heating, can produce domestic hot water, in combination with a storage tank.

The 24A and 28A models are equipped with an automatic brazier cleaning system, called "comb", which allows the deposits elimination and a correct combustion.





# ONDA

VENTILATED PELLET HYDRO-STOVE

Unical

ONDA 17-24-28

ONDA		17	24 A	28 A
NOMINAL INPUT (min-max)	kW	4.1 - 18	8.4 - 24.0	9.0 - 27.4
NOMINAL OUTPUT	kW	17.1	22.8	25.9
MINIMUM OUTPUT	kW	4.0	7.9	8.6
DIRECT HEAT OUTPUT (nom. - min.)	kW	3.7 - 0.9	1.9 - 1.3	5.5 - 2.1
ENERGY CLASS				
EFFICIENCY AT NOMINAL - MINIMUM OUTPUT	%	95.0 - 97.5	94.9 - 94.2	94.6 - 95.8
AVERAGE CONSUMPTION (at min.-nom.)	kg/h	0.84 - 3.70	1.75 - 5.01	1.88 - 5.72
HEATING VOLUME datum referred to well insulated houses. 18/20 °C - coefficient 0.045 kW/m³ (min-max)	m³	89 - 380	226 - 654	246 - 742
PELLET RESERVOIR CONTENT	kg	33	42	57
SMOKE OUTLET Ø	mm	80	80	80
AIR INTAKE DIAMETER	mm	50	50	50
BOILER WATER CONTENT	l	40	50	60
DIMENSIONS (L x D x H)	mm	540 x 590 x 1090	590 x 680 x 1250	700 x 740 x 1370
WEIGHT	kg	154	250	280



Black



White



Burgundy

## PRODUCT PLUS VALUES



HYDRO VENTILATED



MAGIC GLASS



AUTOMATIC BRAZIER CLEANING (mod. 24 A - 28 A)



WI-FI



CAST IRON BRAZIER (mod. 17)



POWER MODULATION



REAR SMOKE OUTLET



WEEKLY PROGRAMMING



REMOTE CONTROL

## OPTIONAL







# T.it K 8.8

PELLET-FIRED KITCHEN

**Pellet-fired kitchen**, fully automatic, ideal for space heating and food cooking, both on the hob and in the oven.

It is possible to provide for a diffusion of heat in adjacent rooms, thanks to the provision of the rear attachment for even retractable ducts.

Daily / weekly programming and remote management with dedicated App (optional Wi-Fi kit)



# T.it K 8.8

**Unical**

T.it K 8.8

PELLET-FIRED KITCHEN

T.it K		8.8
NOMINAL INPUT (min-max)	kW	3.3 - 8.8
NOMINAL OUTPUT	kW	8.0
MINIMUM OUTPUT	kW	3.10
ENERGY CLASS		<b>A+</b>
EFFICIENCY AT NOMINAL OUTPUT	%	90.9
EFFICIENCY AT MINIMUM OUTPUT	%	92.4
AVERAGE CONSUMPTION (at min.-nom.)	kg/h	0.98 - 1.80
HEATING VOLUME datum referred to well insulated houses. 18/20 °C - coefficient 0.045 kW/m³ (min-max)	m³	69 - 178
PELLET RESERVOIR CONTENT	kg	12
SMOKE OUTLET Ø	mm	80
DIMENSIONS (L x D x H)	mm	720 x 540 x 860
WEIGHT	kg	98



Black

White

Burgundy

### PRODUCT PLUS VALUES

- COMPACT KITCHEN
- CERAMIC GLASS
- STEEL BRAZIER
- DAILY / WEEKLY PROGRAMMING
- POWER MODULATION
- "SILENT" FUNCTION
- REAR SMOKE OUTLET

### OPTIONAL

- SIDE SMOKE OUTLET
- DUCTABLE
- WI-FI



COMPATIBLE WITH  
amazon alexa  
Download on the  
App Store  
GET IT ON  
Google Play





# COMPLE 2S

PELLET BOILER • HEATING ONLY  
DHW PRODUCTION (OPTIONAL)

**Pellet fired boiler**, with a high content of technical water, with a revolutionary two-stage pellet feeding system, to guarantee absolute safety. Minimum maintenance, thanks to the presence of an automatic integral cleaning system, which remains active even when the boiler is in operation.

COMPLE 2S is synonymous with high and constant performance, widely measurable with significant savings compared to boilers powered by fossil fuels.

Total control of the boiler is possible, in a few simple gestures, by acting on the new on-board "Touch Screen" display, or even remotely via WiFi (optional).

Hot water production with integrated or remote system (optional).



# COMPLE 2S

Unical

COMPLE 2S

PELLET BOILER • HEATING ONLY  
DHW PRODUCTION (OPTIONAL)

COMPLE 2S		20 R	24 R	34 R
NOMINAL INPUT (min-max)	kW	6.5 - 22	6.5 - 26	6.5 - 33.3
NOMINAL OUTPUT	kW	20.5	24.1	30.6
MINIMUM OUTPUT	kW	6	6	6
ENERGY CLASS		A+	A+	A+
EFFICIENCY AT NOMINAL - MINIMUM OUTPUT	%	93.1 - 92.1	92.6 - 92.1	92.1 - 92
AVERAGE CONSUMPTION (at min.-nom.)	kg/h	1.37 - 4.59	1.37 - 5.39	1.37 - 6.95
AUTONOMY	h	13 - 43.8	11.13 - 43.8	8.64 - 43.8
HEATING VOLUME datum referred to well insulated houses. 18/20 °C - coefficient 0.045 kW/m³ (min-max)	m³	133 - 455	133 - 535	133 - 680
PELLET RESERVOIR CONTENT	l/kg	92.7 / 60	92.7 / 60	92.7 / 60
SMOKE OUTLET Ø	mm	100	100	100
BOILER WATER CONTENT	l	73	73	73
DIMENSIONS (L x D x H)	mm	870 x 600 x 1372	870 x 600 x 1372	870 x 600 x 1372
WEIGHT	kg	382	385	390



## PRODUCT PLUS VALUES

- HEATING ONLY BOILER
- AUTOMATIC BRAZIER CLEANING
- POWER MODULATION
- REAR SMOKE OUTLET
- UPPER SMOKE OUTLET
- DISPLAY TOUCH
- DAILY / WEEKLY PROGRAMMING
- DOUBLE STAR + FEEDING SCREW SYSTEM

## OPTIONAL

- WI-FI
- DHW PRODUCTION

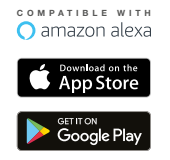



# COMPLE

PELLET FIRED BOILER  
DHW PRODUCTION OR HEATING ONLY

High efficiency pellet fired boiler with high content of technical water (up to 120 liters), with production of domestic hot water as standard.

A complete and compact construction model, **COMPLE** is the solution for a tidy, clean, silent, all-in-one boiler room. Effective protection from heat losses, thanks to the mineral wool insulation placed on the entire perimeter of the exchanger body.

The smoke path, equipped with an automatic timed surface cleaning system, guarantees high and constant performance over time.



# COMPLE

Unical

COMPLE

PELLET FIRED BOILER  
DHW PRODUCTION OR HEATING ONLY

COMPLE		24 / 24 R
NOMINAL INPUT (min-max)	kW	6.23 - 24.09
NOMINAL OUTPUT	kW	22.4
MINIMUM OUTPUT	kW	5.5
ENERGY CLASS		A+
EFFICIENCY AT NOMINAL - MINIMUM OUTPUT	%	92.7 - 88.2
AVERAGE CONSUMPTION (at min.-nom.)	kg/h	1.29 - 4.97
AUTONOMY	h	10
HEATING VOLUME datum referred to well insulated houses. 18/20 °C - coefficient 0.045 kW/m³ (min-max)	m³	122 - 498
PELLET RESERVOIR CONTENT	kg	50
SMOKE OUTLET Ø	mm	100
BOILER WATER CONTENT	l	90
DIMENSIONS (L x D x H)	mm	880 x 660 x 1360
WEIGHT	kg	292



ECO DESIGN  
2020



## PRODUCT PLUS VALUES

- DHW PRODUCTION BOILER
- "R" MODEL HEATING ONLY BOILER
- AUTOMATIC BRAZIER CLEANING
- POWER MODULATION
- REAR SMOKE OUTLET
- UPPER SMOKE OUTLET
- DAILY / WEEKLY PROGRAMMING

## OPTIONAL

- WI-FI
- TOUCH SCREEN SYSTEM WITH ROOM TEMPERATURE SENSOR

COMPATIBLE WITH  
amazon alexa  
Download on the  
App Store  
GET IT ON  
Google Play





# .IT CT 2S

PELLET FIRED BOILER

**High efficiency pellet-fired boiler** with forced hot water circulation, suitable for boiler house or technical room. A single and practical source of heat to warm and give well-being to all rooms in the house, to protect daily comfort in complete safety.

**PUNTO IT CT 2S** in addition to heating, can produce domestic hot water, if connected to an optional external storage tank. Timed cleaning of the cast iron brazier, possibility of creating multi-zone systems, backlit LCD control panel for management and programming of switching on and off.



# PUNTO IT CT 2S

PELLET FIRED BOILER

Unical

PUNTO IT CT 2S

PUNTO IT CT 2S		15	20	24	28	33
NOMINAL INPUT (max)	kW	15.1	19	23	27.1	31.5
NOMINAL OUTPUT	kW	13.8	17.5	21	25	29
MINIMUM OUTPUT	kW	4.1	5.2	6.3	6.3	6.3
ENERGY CLASS		A+	A+	A+	A+	A+
EFFICIENCY AT NOMINAL OUTPUT	%	91.2	91.2	91.2	91.2	91.2
AVERAGE CONSUMPTION (at min.-nom.)	kg/h	0.91 - 3.3	1.2 - 3.9	1.4 - 4.7	1.4 - 5.5	1.4 - 6.4
AUTONOMY (at min.-nom.)	h	50 - 14	44 - 15.5	42.8 - 12.8	56 - 14.5	56 - 12
HEATING VOLUME datum referred to well insulated houses. 18/20 °C - coefficient 0.045 kW/m³ (max)	m³	290	380	430	540	620
PELLET RESERVOIR CONTENT	l/kg	70 / 46	92 / 60	92 / 60	123 / 80	123 / 80
SMOKE OUTLET Ø	mm	80	80	80	100	100
BOILER WATER CONTENT	l	31	50	50,5	60	61
DIMENSIONS (L x D x H)	mm	562 x 701 x 1081	610 x 786 x 1240	610 x 786 x 1240	670 x 867 x 1358	670 x 867 x 1358
WEIGHT	kg	158	240	241	290	292



## PRODUCT PLUS VALUES



HEATING ONLY  
BOILER



CAST IRON  
BRAZIER



POWER  
MODULATION



WI-FI



REAR SMOKE  
OUTLET



DAILY / WEEKLY  
PROGRAMMING

## OPTIONAL





# LAmix +34 2S

Unical

LAmix +34 2S

DUAL FUEL, WOOD LOGS-PELLET, FIRED BOILER



## PRODUCT PLUS VALUES



DUAL FUEL, WOOD LOGS-PELLET, FIRED BOILER



INVERSED FLAME



POWER MODULATION



SOLAR CIRCUIT MANAGEMENT



ADJUSTABLE SMOKE OUTLET



UFLY

## OPTIONAL



WI-FI



ECO DESIGN 2020



## LAmix +34 2S

		PELLET fired	WOOD fired
NOMINAL INPUT (min.-max.)	kW	10.7 - 34.4	16.3 - 34.4
NOMINAL OUTPUT	kW	31.4	31.5
MINIMUM OUTPUT	kW	9.6	17.7
ENERGY CLASS		A+	A+
EFFICIENCY AT NOMINAL - MINIMUM OUTPUT	%	90.1 - 91.7	90.5 - 92
AVERAGE CONSUMPTION (min-max)	kg/h	4.66 - 8.9	4 - 7.1
AUTONOMY	h	4	32
HEATING VOLUME datum referred to well insulated houses. 18/20 °C - coefficient 0.045 kW/m³ (max)	m³	680	680
PELLET RESERVOIR CONTENT (opzionale)	kg	225-320	-
WOOD STORAGE VOLUME	l	-	100
WOOD LOGS LENGTH	m	-	0.5
SMOKE OUTLET Ø	mm	150	150
BOILER WATER CONTENT	l	102	102
SUGGESTED VOLUME OF THERM ACCUM.	l	> 1200 ÷ 2000	> 1200 ÷ 2000
DIMENSIONS (L x D x H)	mm	660 x 1288 x 1500	660 x 1288 x 1500
WEIGHT	kg	557	557

**Dual fuel boiler**, working with wood logs and pellet, with high performances thanks to the combustion chamber in carbon steel with flame inversion (invention and historical patent of Unical), and the pellet burner positioned on suction side. The wood logs storage is in special carbon steel with a thickness of 8 mm. Automatic cleaning with blade turbulators, operated by rods and rockers with timed programming, practical extraction of the ashes from the front. Automatic pellet loading. Ufly Touch Screen TFT control panel. Optional pellet tank.

# LAwood 34L 2S







WOOD LOGS-FIRED BOILER • INVERSED FLAME

**Unical**

LAwood 34L 2S



## PRODUCT PLUS VALUES

-  WOOD LOGS-FIRED BOILER
-  INVERSED FLAME
-  POWER MODULATION
-  SOLAR CIRCUIT MANAGEMENT
-  ADJUSTABLE SMOKE OUTLET
-  UFLY



## OPTIONAL

-  WI-FI



## LAwood

## 34L 2S

NOMINAL INPUT (min.-max.)	kW	16.3 - 34.7
NOMINAL OUTPUT	kW	31.3
MINIMUM OUTPUT	kW	16.2
ENERGY CLASS		
EFFICIENCY AT NOMINAL - MINIMUM OUTPUT	%	91.7 - 92
AVERAGE CONSUMPTION (min-max)	kg/h	5.12 - 8.6
AUTONOMY	h	4
HEATING VOLUME datum referred to well insulated houses. 18/20 °C - coefficient 0.045 kW/m³ (max)	m³	680
WOOD STORAGE VOLUME	l	100
WOOD LOGS LENGTH	m	0,5
SMOKE OUTLET Ø	mm	150
BOILER WATER CONTENT	l	102
SUGGESTED VOLUME OF THERM ACCUM.	l	> 1200 ÷ 2000
DIMENSIONS (L x D x H*)	mm	660 x 1141 x 1500
WEIGHT	kg	558

**High performance wood-fired boiler** thanks to the inversed flame technology (invention and historical patent of Unical), it is equipped with regulation controlling the optimization of the gasification. The capacious wood store ensures long autonomy with a single charge. Ufly Touch Screen TFT control panel. Lambda Modul System: for monitoring through a lambda probe and for a total combustion control with the utmost environment protection.



# FIREX 2S

WOOD LOGS - FIRED BOILER

Unical

FIREX 2S



## PRODUCT PLUS VALUES



HEATING ONLY BOILER



INVERSED FLAME



REAR SMOKE OUTLET



SOLAR CIRCUIT MANAGEMENT



FIREX 2S		34	45	55
NOMINAL INPUT	kW	34	45	55
NOMINAL OUTPUT	kW	34.2	45	55.2
MINIMUM OUTPUT	kW	30.6	40.1	49.1
ENERGY CLASS		A+	A+	A+
EFFICIENCY AT NOMINAL OUTPUT	%	89.5	89.1	89.1
AVERAGE CONSUMPTION	kg/h	9.6	14.2	19.4
AUTONOMY	h	5	6	6
HEATING VOLUME datum referred to well insulated houses. 18/20 °C - coefficient 0.045 kW/m³ (max)	m³	680	891	1091
WOOD STORAGE VOLUME	l	108	160	218
WOOD LOGS LENGTH	m	0.5	0.5	0.7
SMOKE OUTLET Ø	mm	150	200	200
BOILER WATER CONTENT	l	59	71	93
SUGGESTED VOLUME OF THERM ACCUM.	l	> 1200 ÷ 2000	> 1200 ÷ 2000	> 1200 ÷ 2000
DIMENSIONS (L x D x H*)	mm	510 x 995 x 1230	610 x 995 x 1380	610 x 1195 x 1380
WEIGHT	kg	363	475	623

\*excluding control panel: height 190 mm

Steel, wood-fired boiler, total gasification, flame inversion (invention and historical patent of Unical), thermo-controlled pyrolytic combustion with fan placed on suction side. Biotronic ON-OFF control panel for automatic management of the boiler fan and of the various types of systems. Anti-overheating safety heat exchanger and automatic fumes bypass.

# System with hydro-stove

Unical hydro-stoves can be adapted to existing systems, also **in combination with other renewable energy sources**, to heat the house and produce domestic hot water. The hydro-stove controls and optimizes the consumption according to the needs.

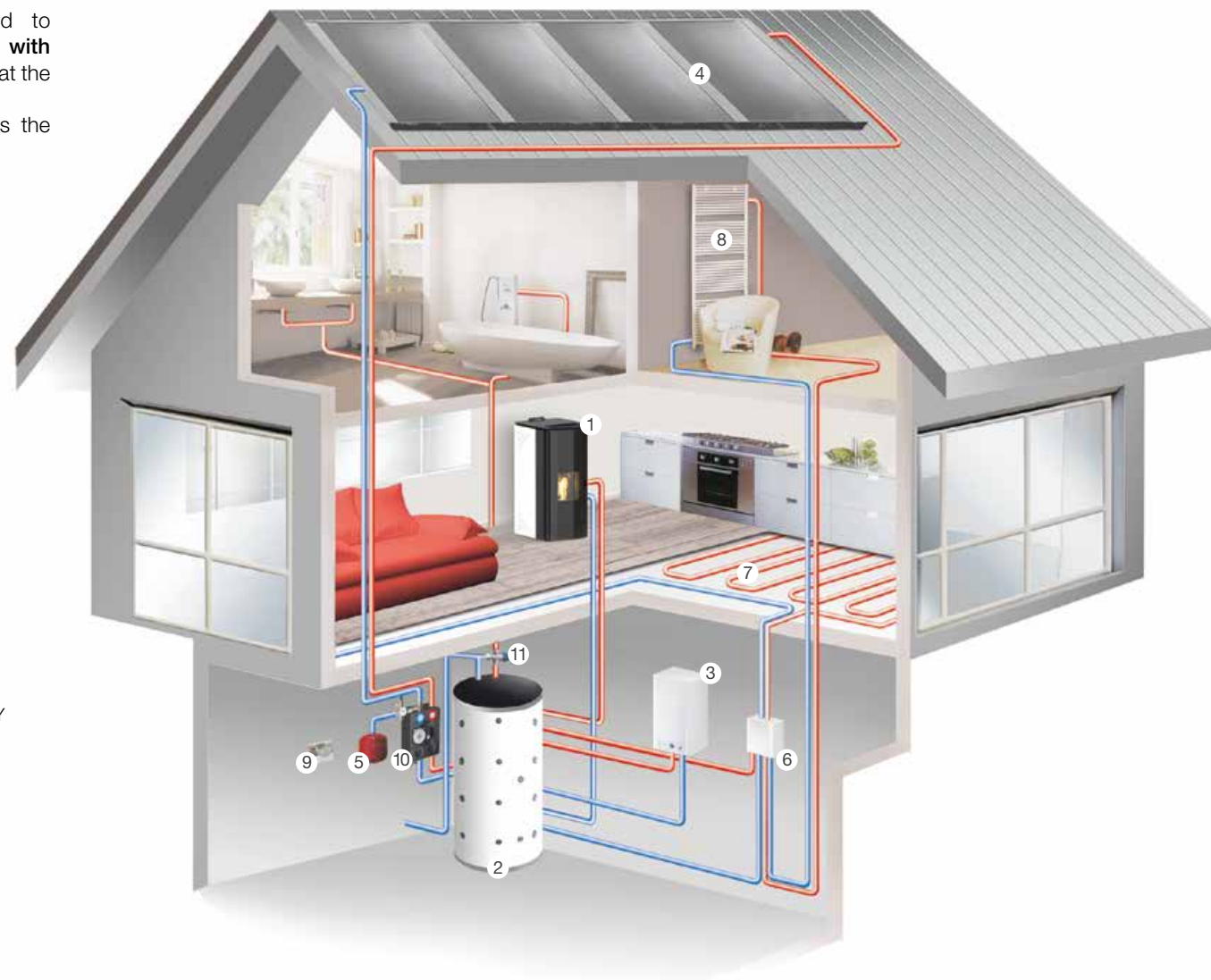

- 1 HYDRO-STOVE
- 2 BUFFER TANK WITH COIL FOR SOLAR INTEGRATION
- 3 WALL-HUNG BOILER FOR HEATING ONLY
- 4 SOLAR COLLECTORS
- 5 SOLAR EXPANSION VESSEL
- 6 DISTRIBUTION MODULE
- 7 FLOOR HEATING SYSTEM
- 8 RADIATOR HEATING SYSTEM
- 9 SOLAR CONTROL UNIT
- 10 SOLAR CIRCULATION GROUP
- 11 THERMOSTATIC MIXER

SYSTEM DIAGRAM OF PELLETT-FIRED HYDRO-STOVE WITH ROOM TEMPERATURE SENSOR AND DHW TANK

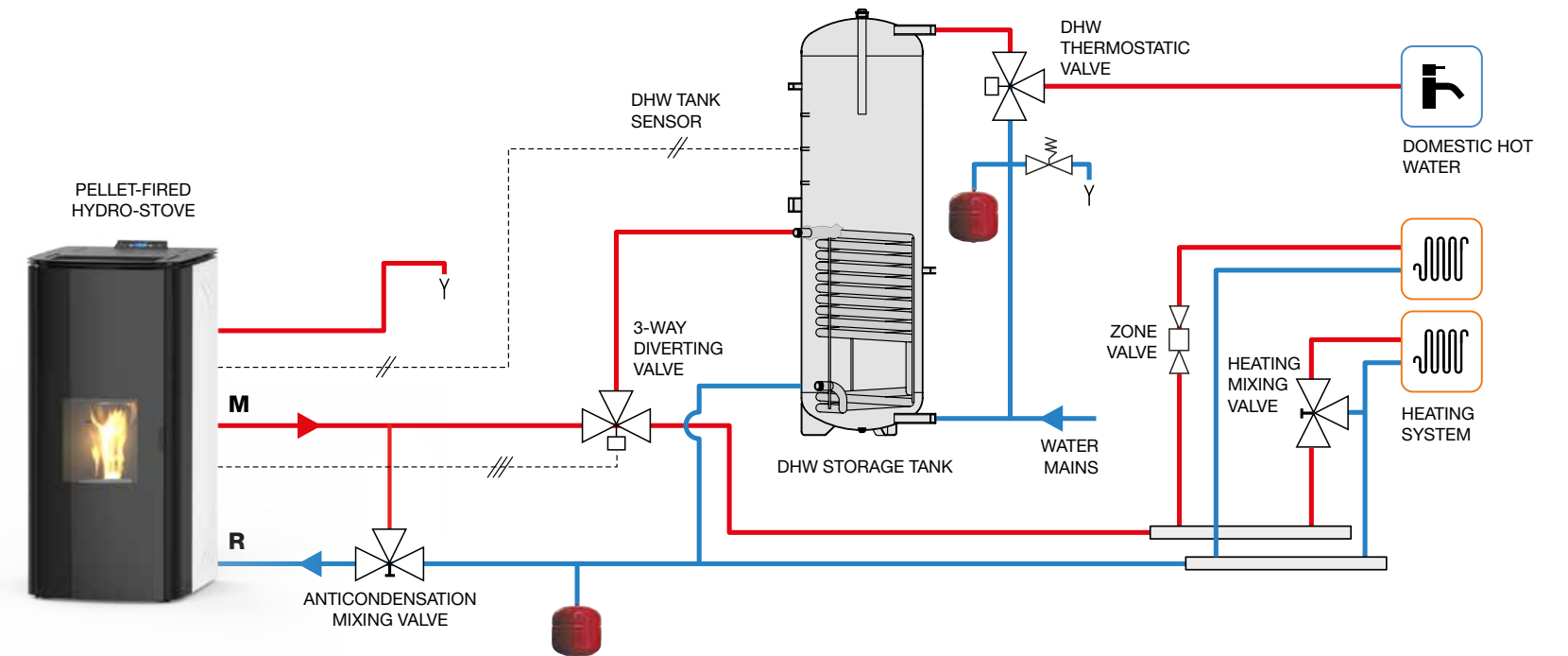

These schemes are purely indicative. The thermo-hydraulic system must be built according to the regulations in force and equipped with all the control / safety accessories.



# System with boiler

Unical pellet-fired boilers can be **combined with other renewable energy sources** to heat the house. Solar panels, radiant floor systems, DHW storage tanks, heat pumps, control systems are easily connected to ensure maximum performance and optimized consumption according to the user's needs.

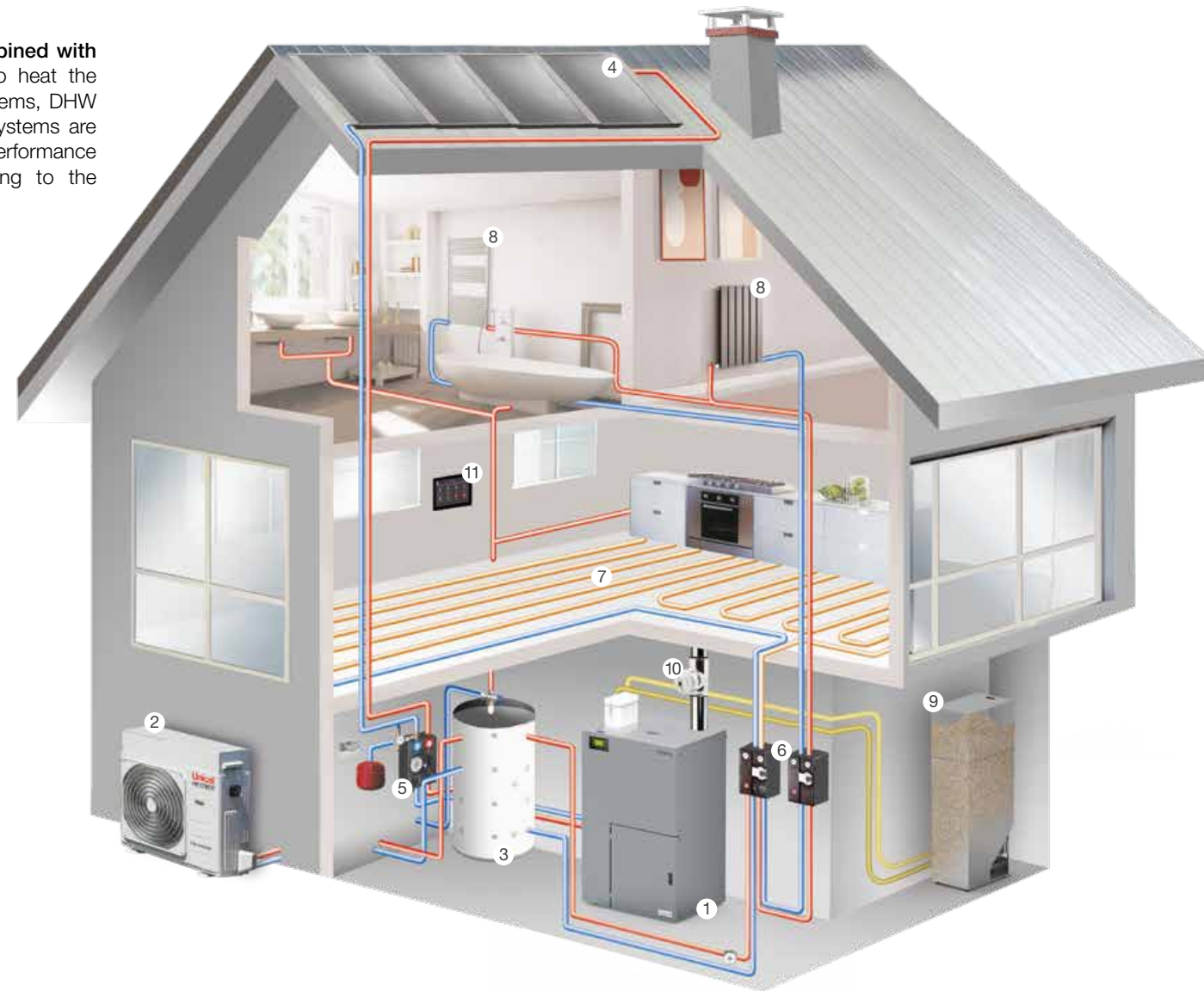

- 1 PELLETT-FIRED BOILER
- 2 HEAT PUMP
- 3 PRIMARY WATER BUFFER
- 4 SOLAR COLLECTORS
- 5 SOLAR THERMAL GROUP
- 6 LT / HT PUMPING GROUP
- 7 FLOOR HEATING SYSTEM (LT)
- 8 RADIATOR HEATING SYSTEM (HT)
- 9 MOTORIZED PELLETT STORAGE
- 10 DRAFT ADJUSTER
- 11 TOUCH SCREEN PANEL

SYSTEM DIAGRAM WITH PELLETT-FIRED BOILER FOR HEATING AND DHW PRODUCTION WITH EXTERNAL BUFFER AND CONNECTION TO SOLAR PANELS

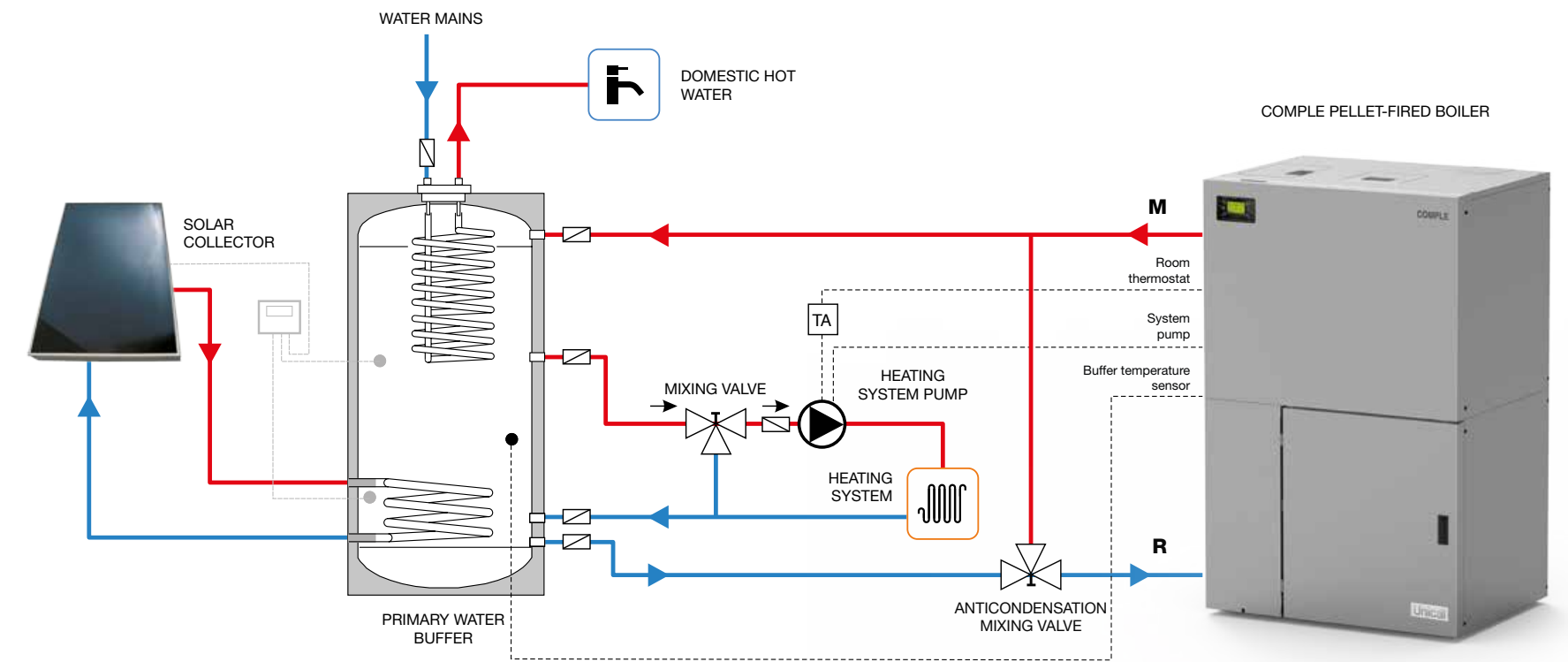

These schemes are purely indicative. The thermo-hydraulic system must be built according to the regulations in force and equipped with all the control / safety accessories.

# Bioenergy is renewability

## Low environmental impact and environmentally friendly products

Industrial production has always had a very important impact on the planet, whether we are talking about production processes or products.

Producing boilers and stoves, as well as automotive or various machinery, means having an additional responsibility, means having an ethical approach starting from the design and up to the disposal of the product.

Finding solutions that integrate the search for products always more eco-friendly and with low environmental impact with everyday well-being, ease of use, advanced technology, beauty, is an integral part of our mission, as well as raising awareness of the public and sector employees towards an ever greater active awareness.

For this reason, we also ask our customers to install, feed and maintain the products in a suitable way, above all following the regulations, as well as to use them with attention and respect for the environment, just as we are committed to following targeted production rules, with low impact on the territory, on people and on the ecosystem.

Renewability means intelligent use of resources; on this planet, often suffering from waste, in addition to seeking new solutions, pursuing advanced technology, promoting renewable energy sources, reducing emissions, it is important to maintain, differentiate, recycle, for ethical savings.



For Unical, producing stoves, hydro-stoves and boilers operating with certified wood biomass means guaranteeing a low environmental impact, which is absolutely healthier and cheaper for the planet.

The primary direction of Unical research is sustainability. The objective of Unical products is, in line with the requirements of the most restrictive European standards, to help protect the environment as much as possible, significantly reduce combustion emissions including the production of CO<sub>2</sub>, thus making heating with biomass fuel (wood, pellets, etc.) increasingly ecological, as well as safe and with maximum user comfort.

The term biomass indicates all those materials of organic / vegetable origin which, unlike hydrocarbons, have not undergone fossilization processes (unlike oil, coal or natural gas).

## Why burn wood (or derivatives) and therefore trees and plants, instead of other fossil fuels?

Simple, nature itself shows us how it is possible to keep our system in balance.

In fact, thanks to the mechanism of chlorophyll photosynthesis, the sun and plants ensure the right proportion of oxygen to the air we breathe. Plants absorb carbon dioxide from the atmosphere **(1)**, thus recovering carbon, necessary for their growth and, at the same time, they return oxygen, essential to our life and that of the planet **(2)**.

During proper combustion, the carbon of the wood **(3)**, combined with the oxygen in the air, produces the exact amount of carbon dioxide absorbed by the tree during its life cycle **(4)**.

While fossil fuels are subject to depletion, wood, pellets and other wood products represent a renewable source of energy.

For this reason, installing a Unical appliance running on pellets, wood or dual fuel is an "eco-friendly" choice, responsible towards our planet, while guaranteeing maximum comfort.

## CYCLE OF NATURE

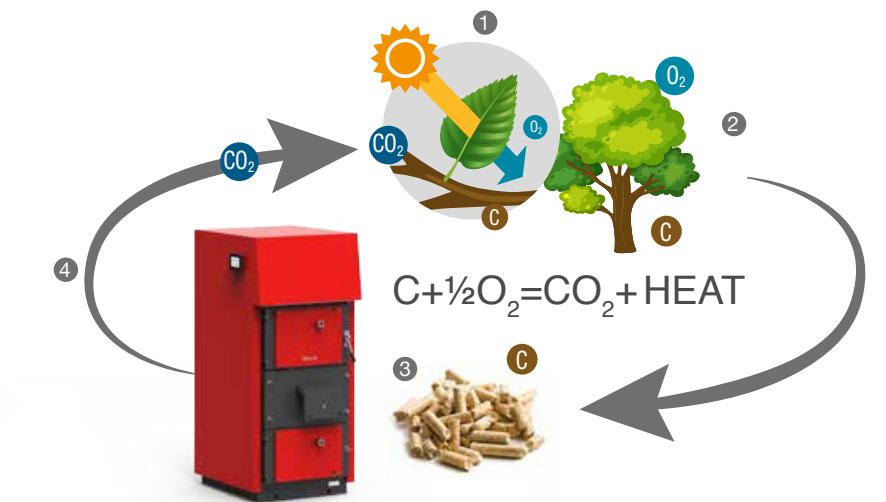

- 1 Chlorophyll photosynthesis: leaves absorb carbon dioxide from the atmosphere.
- 2 They recover carbon, their nourishment to live and grow, producing oxygen.
- 3 Wood obtained from trees is therefore a product of photosynthesis and is composed of carbon.
- 4 By burning wood (or derivatives) in the hearth, the carbon combines with oxygen and, thanks to the double combustion, releases the same amount of carbon dioxide that the tree had removed from the atmosphere to produce the wood.
- 5 The CO<sub>2</sub> emitted by the chimney is equal to the CO<sub>2</sub> absorbed by the plant. This is why it can be defined as "zero environmental impact".



# Regulations and certifications



The ECODESIGN regulation establishes the requirements and methods of application of Directive 2009/125 / EC of the European Parliament and the Council of the European Union, regarding the eco-design criteria for biomass appliances.

The objective of the regulation is to improve the environmental performance of new biomass heat generators and that is why, starting from its entry into force, only appliances capable of meeting the required efficiency and emissions limits can be marketed.

The regulation is mandatory and must be directly applied by each of the member States of the European Union starting from:

- **January 1st, 2020**  
for biomass boilers (EU Regulation 2015/1189)
- **January 1, 2022**  
for biomass household appliances, such as:  
stoves, fireplaces and kitchens (EU Regulation 2015/1185).

## Product certifications

Unical appliances are submitted to independent Notified Bodies for an evaluation, based on the strictest European laws. Subsequently, the Notified Bodies certify the product's high efficiency and low emissions, as required by various national and regional laws.



Conformity mark to european normatives

## EN 14785

European reference standard for pellet fired stoves

## EN 13240

European reference standard for wood logs fired stoves

## EN 13229

European reference standard for inserts and fireplaces

## EN 303.5

European reference standard for solid fuels boilers

# Energy Label

The European Energy Label provides consumers with accurate information on the energy consumption and performance of stoves, hydro-stoves, kitchens and boilers, both wood and pellet-fired.

Unical appliances are designed and built with a particular attention to energy saving, reaching and widely exceeding class A for most of the products.

As for household appliances, thanks to the Energy Label, the consumer can identify the energy characteristics of the product, such as:

- The name or brand of the supplier and the model identifier;
- the energy efficiency class of the appliance, according to a scale ranging from G to A ++;
- the direct thermal power of the appliance, i. e. the nominal Output, expressed in kW.

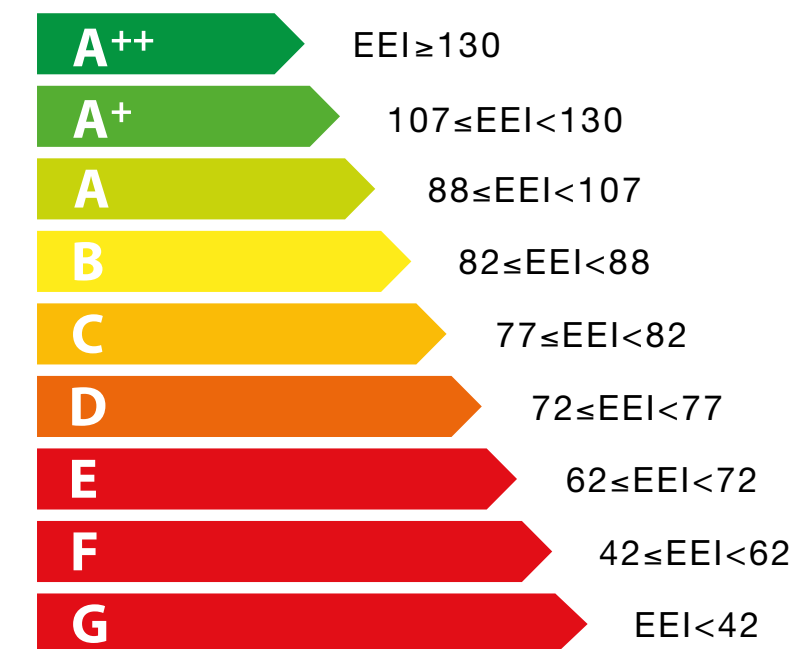

## Example of STOVE energy label

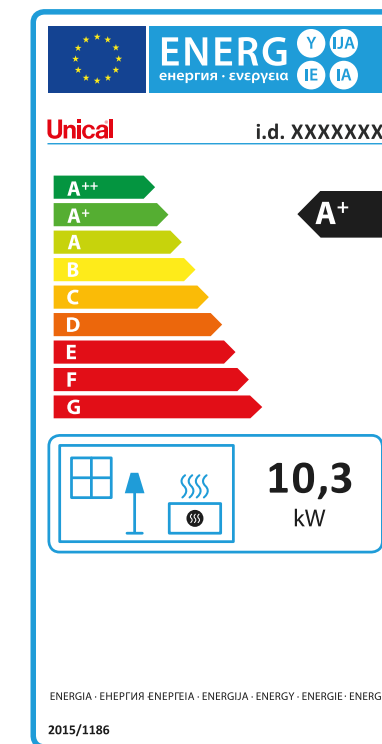

## Example of the HYDRO-STOVE energy label

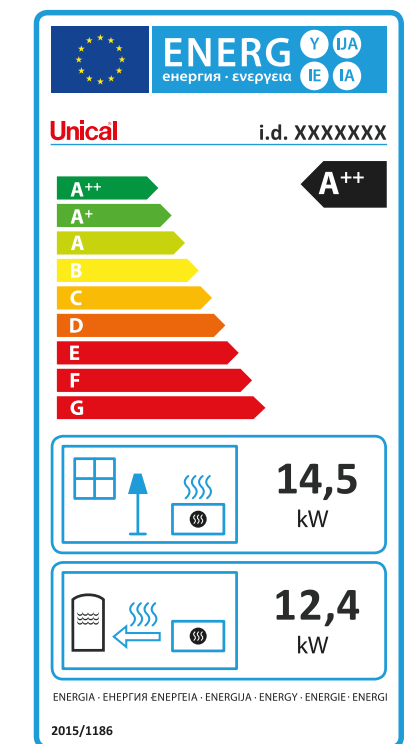



CUBA 5 page 6



TUA 6 2S page 10



FATA page 14



FATAv page 18



NUA page 22



TESI 10 page 26



EBA 11C page 30



MAGA 11 page 34



TIRA 16C page 38



LENI 10 page 42



LENI 10 ceramic page 44



LENI 13 page 46



ONDA page 48



T.it K 8,8 page 52



COMPLE 2S page 56



PUNTO IT CT 2S 15+33 page 64

# Unical

Unical declines any liability for the inaccuracies that may appear due to errors in transcription or printing. It also reserves the right to introduce those modifications to its products that it considers necessary or useful, without compromising the essential characteristics of the said products.





[www.unical.eu](http://www.unical.eu)